

Oxide Thermoelectric Devices: A Major Opportunity for the Global Ceramics Community

David R. Clarke

Materials Discovery and Application Laboratory
School of Engineering and Applied Sciences
Harvard University



Why High-Temperature Thermoelectric Devices ?

- Despite low efficiencies, there are opportunities for thermoelectric devices at high temperatures.
- Lessons from the development of Light Emitting Diodes (LEDs)
- Oxides have intrinsic advantages at high temperatures
- Use of Data mining
- Natural superlattice compounds as alternatives to nanostructuring engineering
- Materials challenges in high temperature thermoelectrics
- Ceramics processing offers new manufacturing paradigms for thermoelectric devices
- International collaboration is highly desirable and essential



HARVARD

School of Engineering
and Applied Sciences

Basics: Energy Efficiency of Thermoelectric Materials

Efficiency

$$\eta = \frac{P}{Q} = \frac{T_H - T_C}{T_H} \frac{\sqrt{1 + ZT_m} - 1}{\sqrt{1 + ZT_m} + \frac{T_C}{T_H}}$$

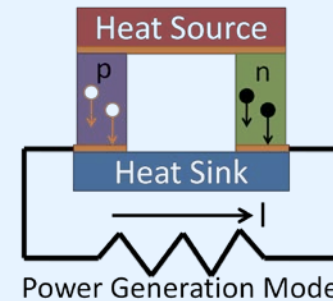

Seebeck coefficient

Electrical conductivity

$$ZT = \frac{S^2 \sigma}{(\kappa_{el} + \kappa_L)} \cdot T$$

Thermal conductivity due to electrons in material

Thermal conductivity due to lattice vibrations

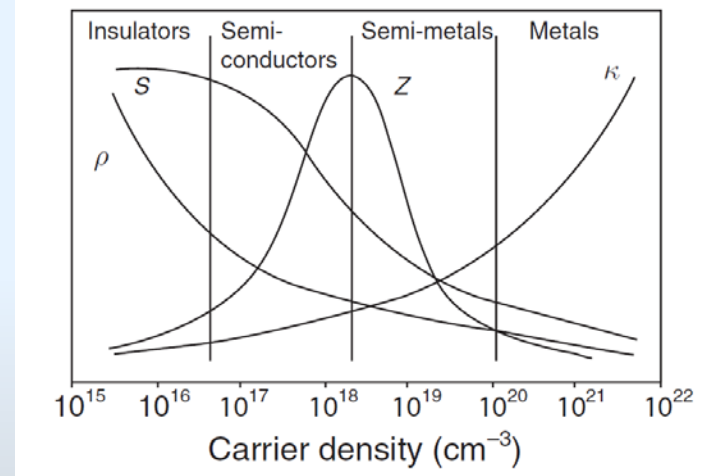

Synder, JPL

Need to both minimize thermal conductivity and maximize power factor, $S^2 \sigma$



Why Use Such Low Efficiency Devices ?

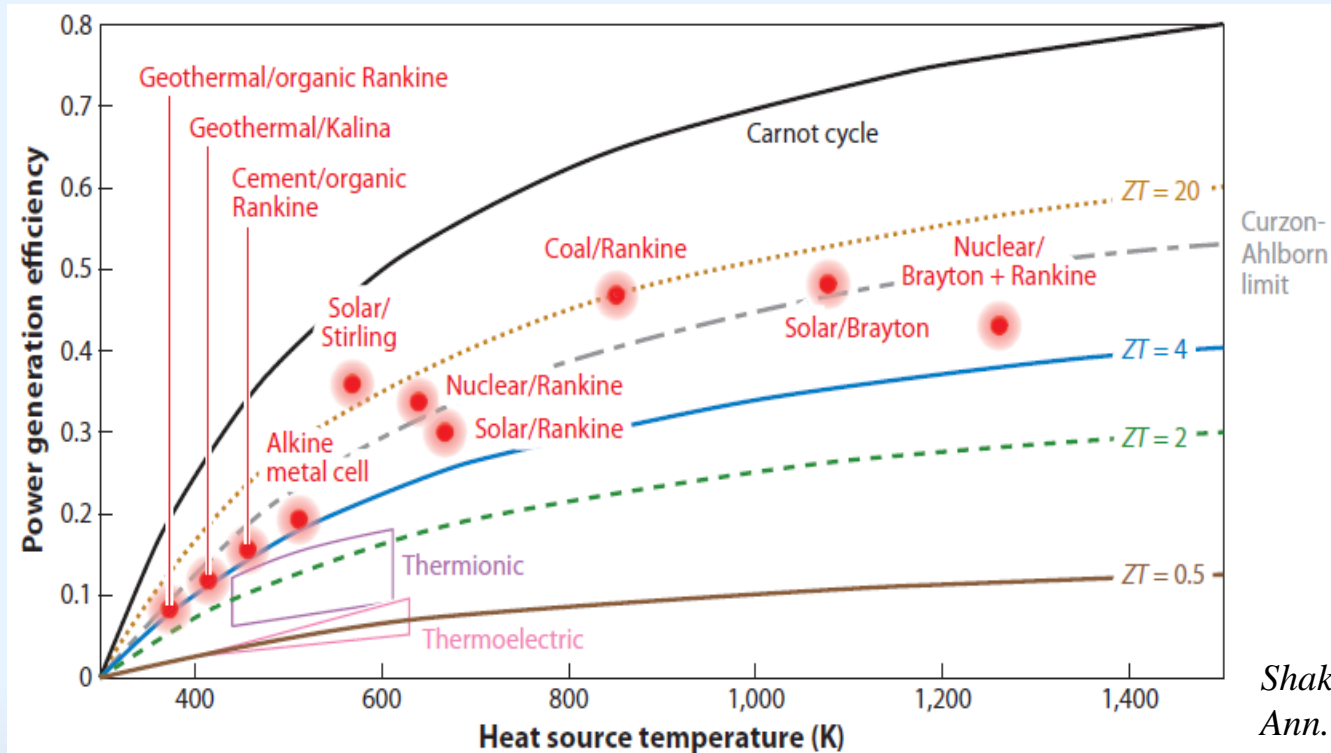

*Shakouri,
Ann. Rev. Mater. Res.*

High efficiencies are not so important to life-cost of thermoelectrics because:

1. Absence of moving parts means there are no long-term maintenance cost
2. Long life expectancy 20-30 years
3. Waste heat is currently discharged



Lessons From Light Emitting Diodes (LEDs)

- LED lights are much more expensive than incandescent bulbs
- Why do organizations buy them ?

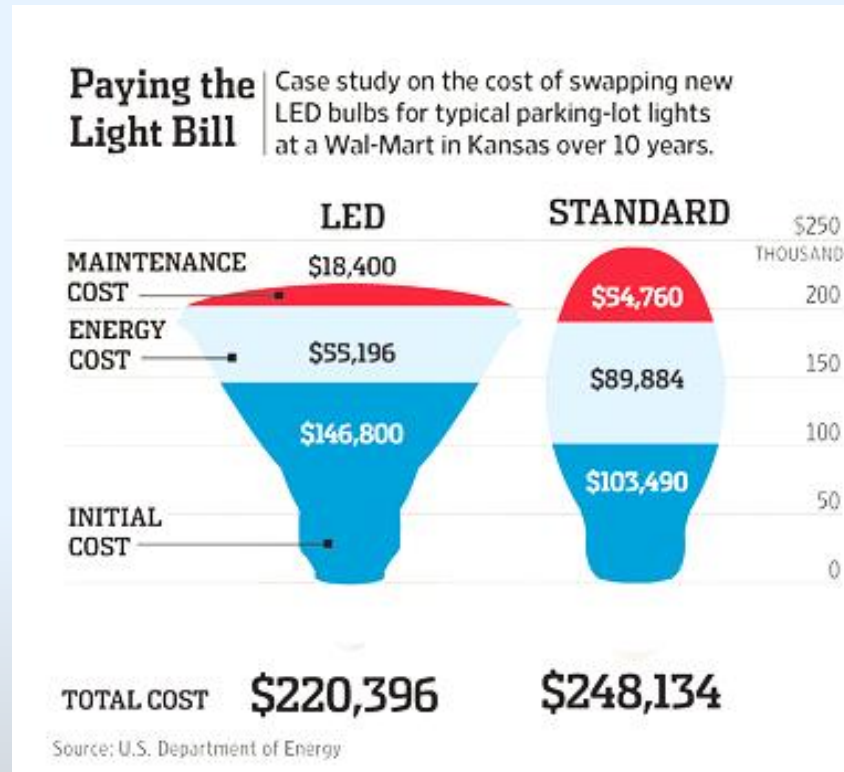

Year 2011

- Life cycle cost is lower than for incandescent bulbs
- Situation is similar for thermoelectric devices



Examples of High Temperatures in Industry

- Exhaust manifolds of combustion engines
 - Small segments of hot pipes but millions of cars.
 - Disadvantage -- Complex geometry
- Chemical plants -- exothermic reactions
 - Kilometers of pipes,
 - Simpler geometry, typically circular pipes
- Metallurgical industries
 - smelting, casting
- Gas and steam turbines
 - Tens of thousands of turbines.
- Nuclear reactors
 - Few reactors but kilometer of pipes
- Solar thermal
 - Potential market not known yet



Mercedes AMG

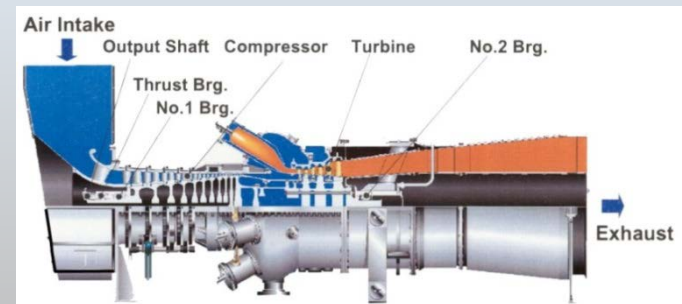

Why Oxide Thermoelectrics ?

- Only oxides are stable in air at high temperatures
- No oxidation protection needed → packaging cost is lower
- Huge number of trivalent and quadra-valent oxides ($\sim 10^5$) are known to exist
 - but very few have been studied in detail
- Many oxides are highly refractory → use at low homologous temperatures
- Cation diffusion rates are low in oxides → so they more resistant to coarsening
- Refractory oxides form from abundant elements and, furthermore,
scarce element oxides are generally not stable at high-temperatures



Figure of Merit of Existing Materials: Data

“Conventional” Thermoelectrics

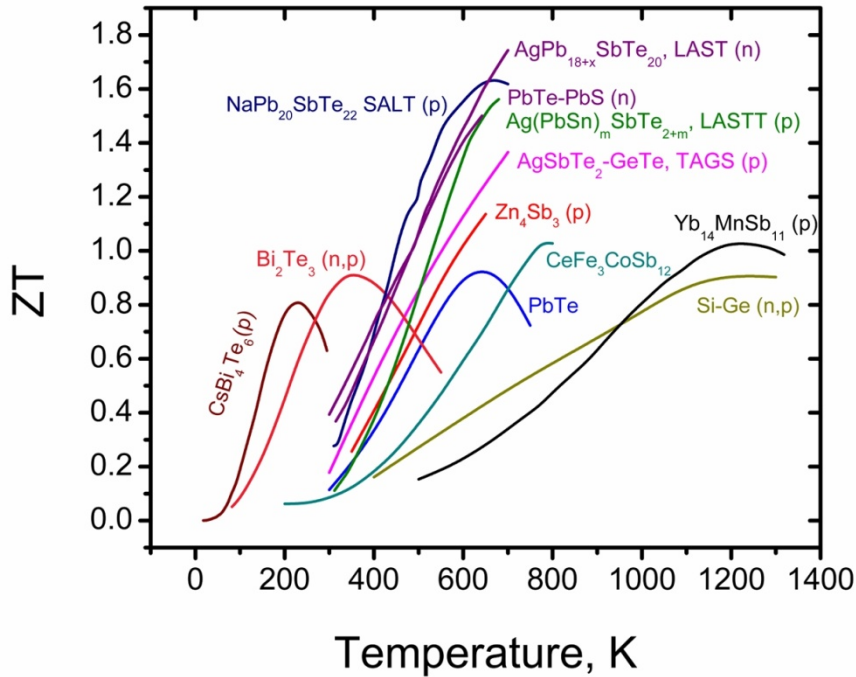

None of these materials is stable in air at high temperatures. Many are also not stable and melt at high temperatures.

Oxide Thermoelectrics

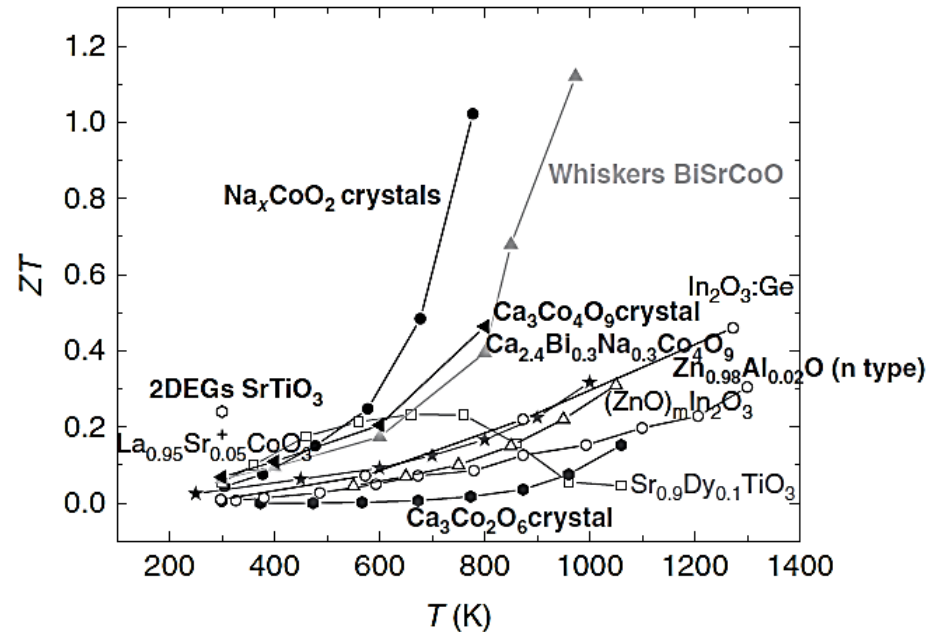

Far fewer oxides have been studied. No nanostructuring so far.



Today's Best Thermoelectric Compounds

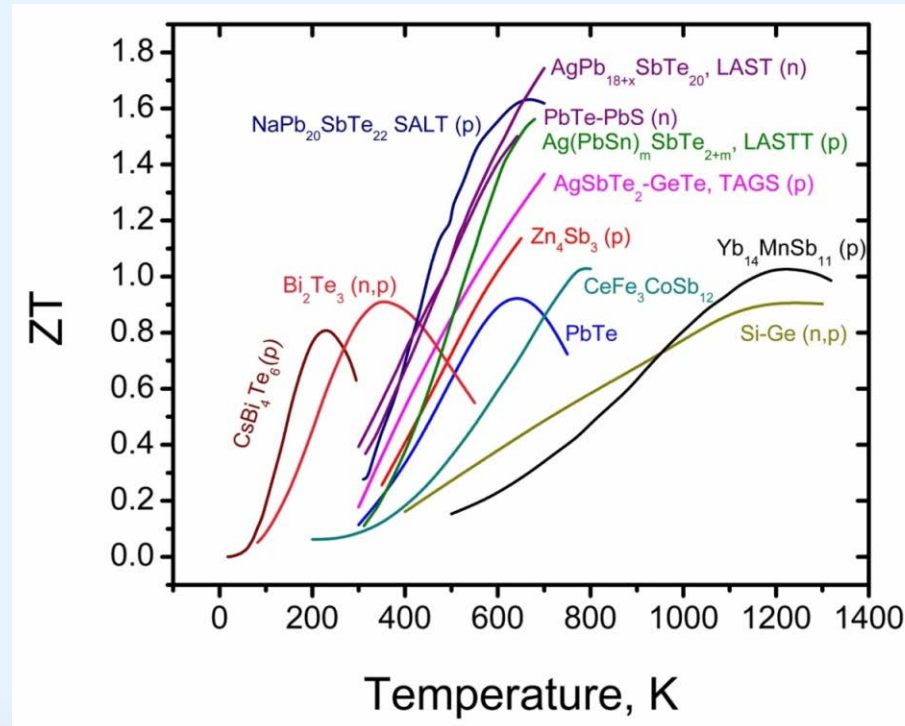

Tober, Synder

Remarkable materials but

*they combine scarce elements and
the high ZT's are based on microstructural refinement !*

Need Commonly occurring elements in compounds that also don't depend on microstructural refinement for high ZT's

Data Mining

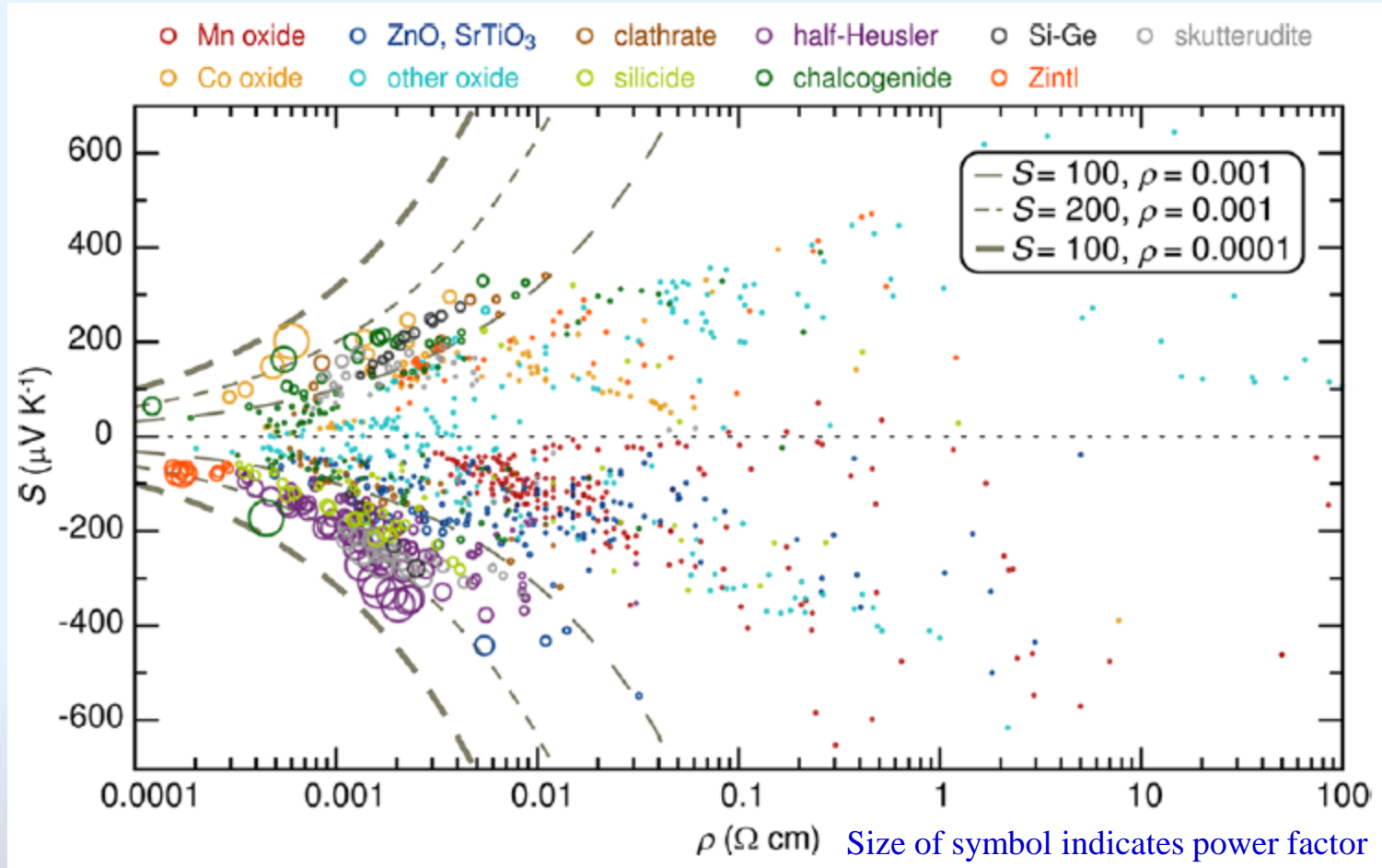

“Data Driven Review of Thermoelectric Materials”,
M. W. Gaultois et al, *Chemistry of Materials*, 25 2911 (2013)



Materials Scarcity: Herfindahl-Hirschman Index

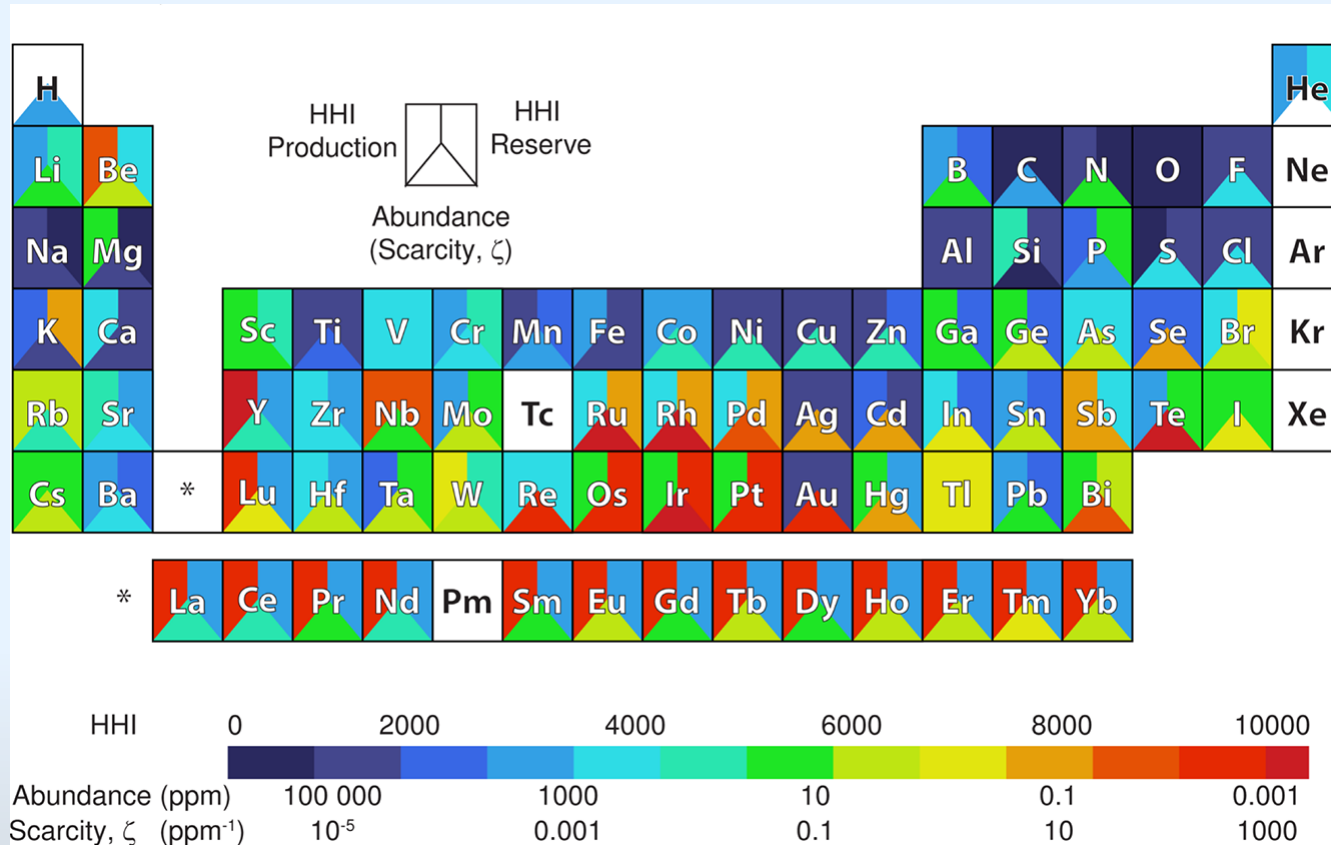

Large scale, high volume use requires abundant (blue) elements

“Data Driven Review of Thermoelectric Materials”,
M. W. Gaultois et al, *Chemistry of Materials*, 25 2911 (2013)

Materials Selection Tool

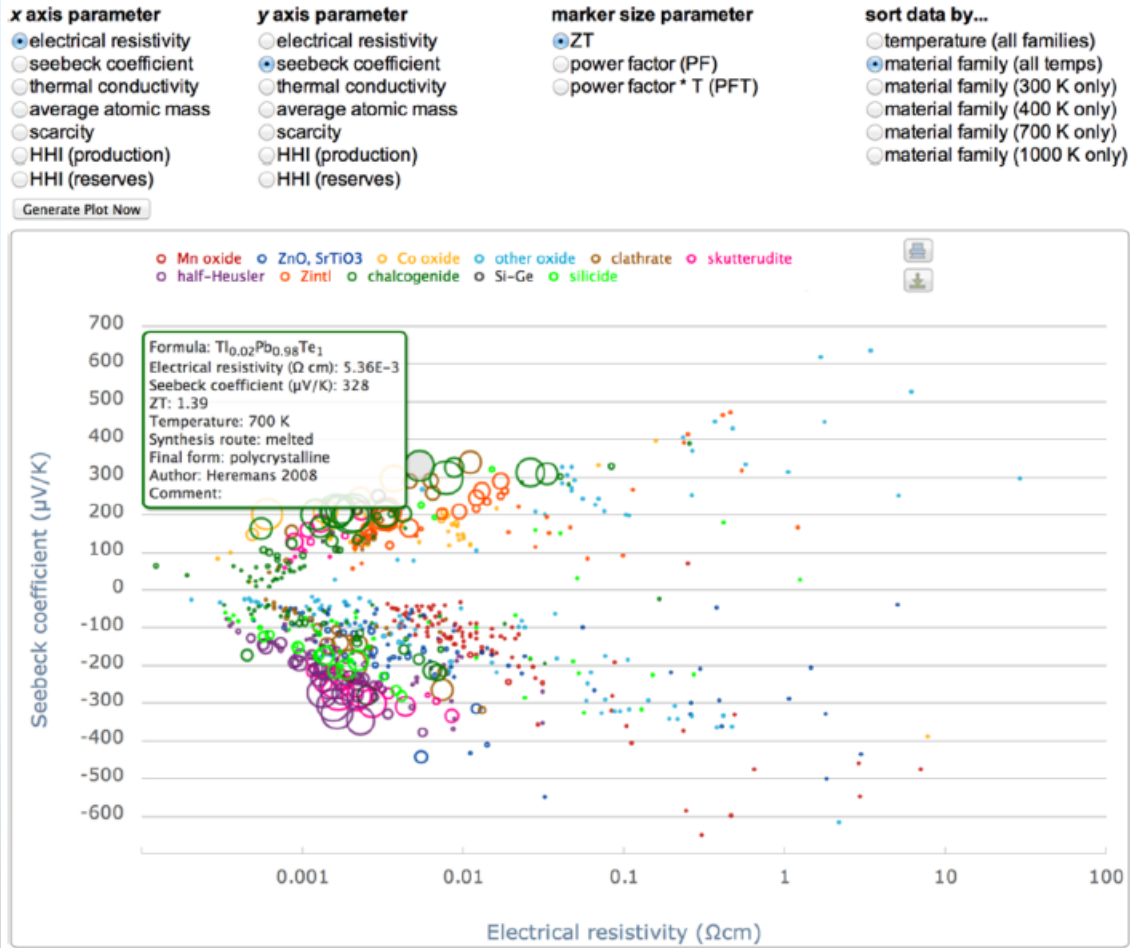

“Data Driven Review of Thermoelectric Materials”,
M. W. Gaultois et al, *Chemistry of Materials*, 25 2911 (2013)



High-Temperature Diffusion : Achilles' Heel of Nanostructuring

- Many of the high values of ZT are achieved as a result of nano-structuring (refining the microstructure scale to reduce thermal conductivity)
- All microstructures coarsen (Ostwald ripening).
- Coarsening is a thermally-activated diffusional process.
- Key temperature is the homologous temperature, T/T_m
- For a single diffusional process, the nanostructural coarsening rate, r

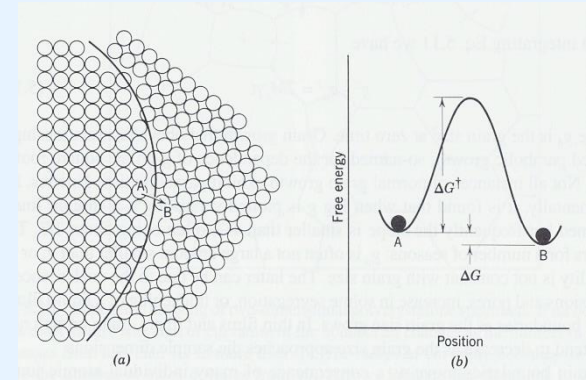

$$r = A \exp(-Q/RT) \quad \longrightarrow \quad \text{LMP} = Q/R = T[C + \ln(t)]$$

Larson-Miller parameter C

- **Conclusion:**
 - High-temperature thermoelectric devices cannot rely on nanostructuring
 - Thermodynamically-stable nanostructuring is required.



Natural Superlattices (Polysomes – Modular Phases – Homologous series)

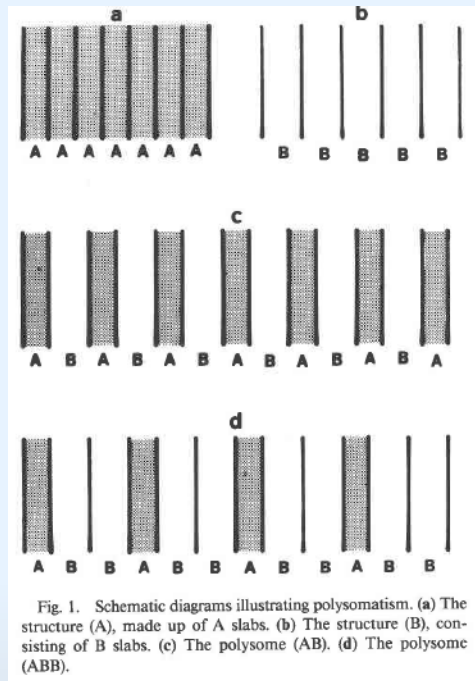

Nano-scale spacing fixed by composition not processing. So they do not coarsen with time at high temperatures

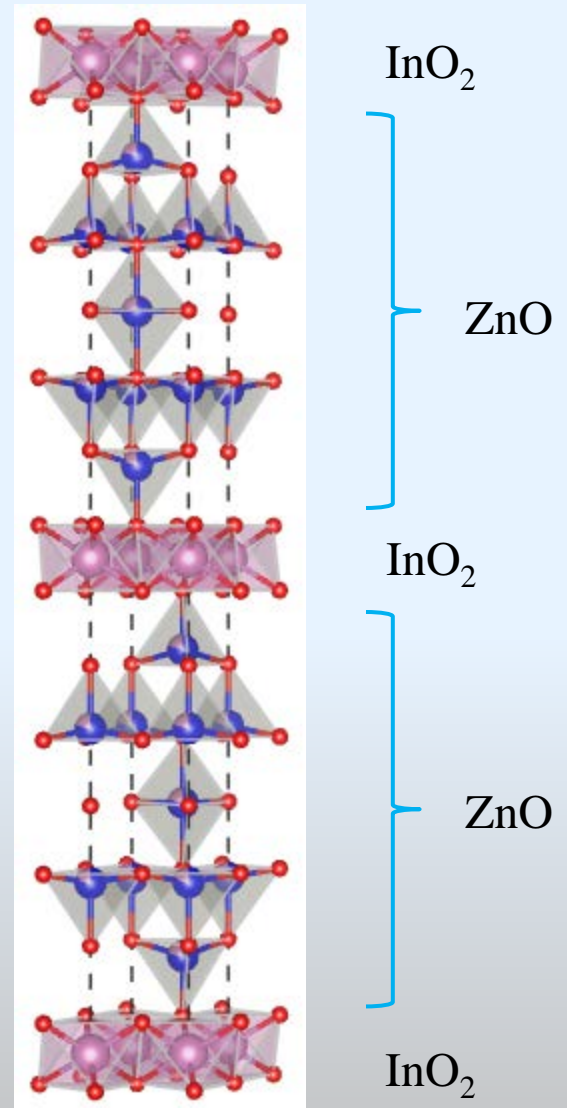
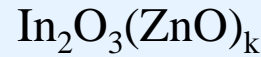

Natural Superlattice in $(\text{ZnO})_k\text{-In}_2\text{O}_3$

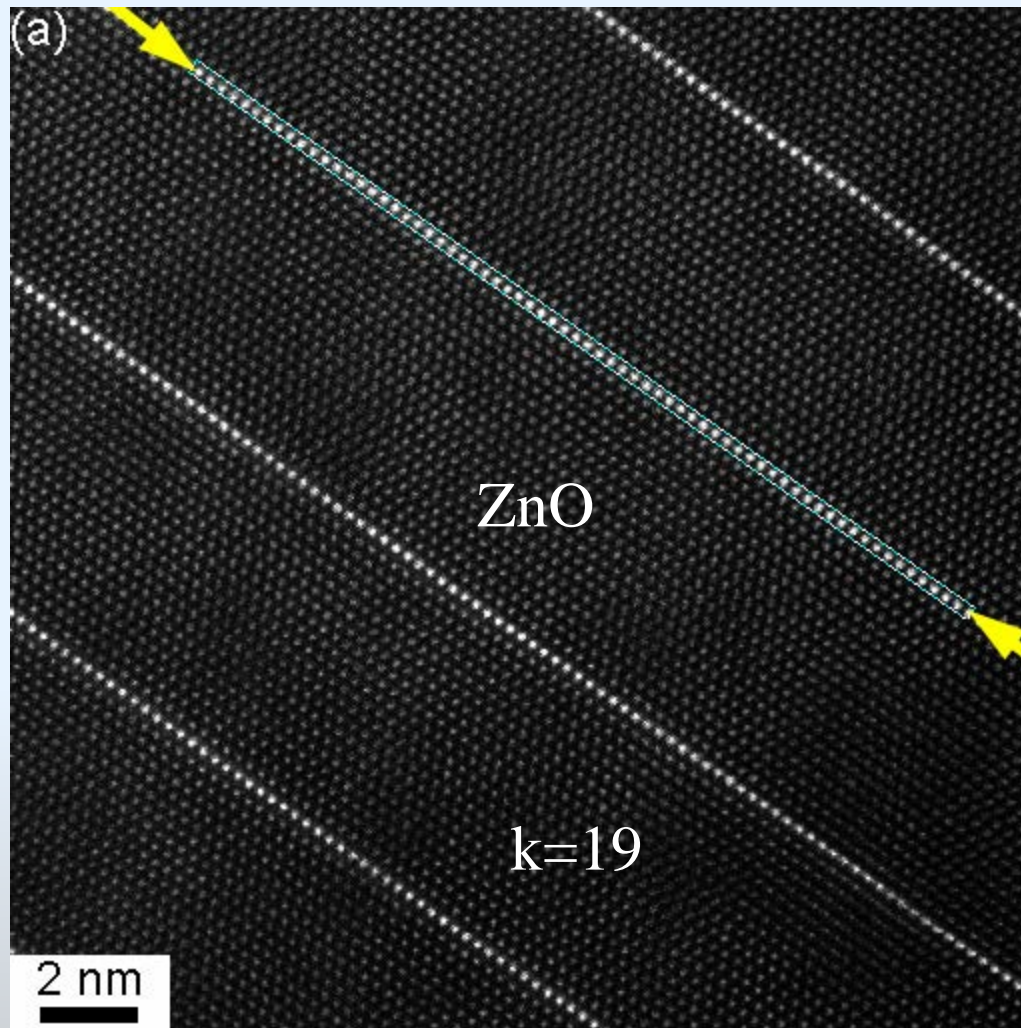

STEM-ADF
image

Monolayer
 InO_2 sheets

Interface Thermal Resistance: $5 \times 10^{-10} \text{ m}^2\text{K/W}$

ZnO-InO_{1.5} Phase Diagram

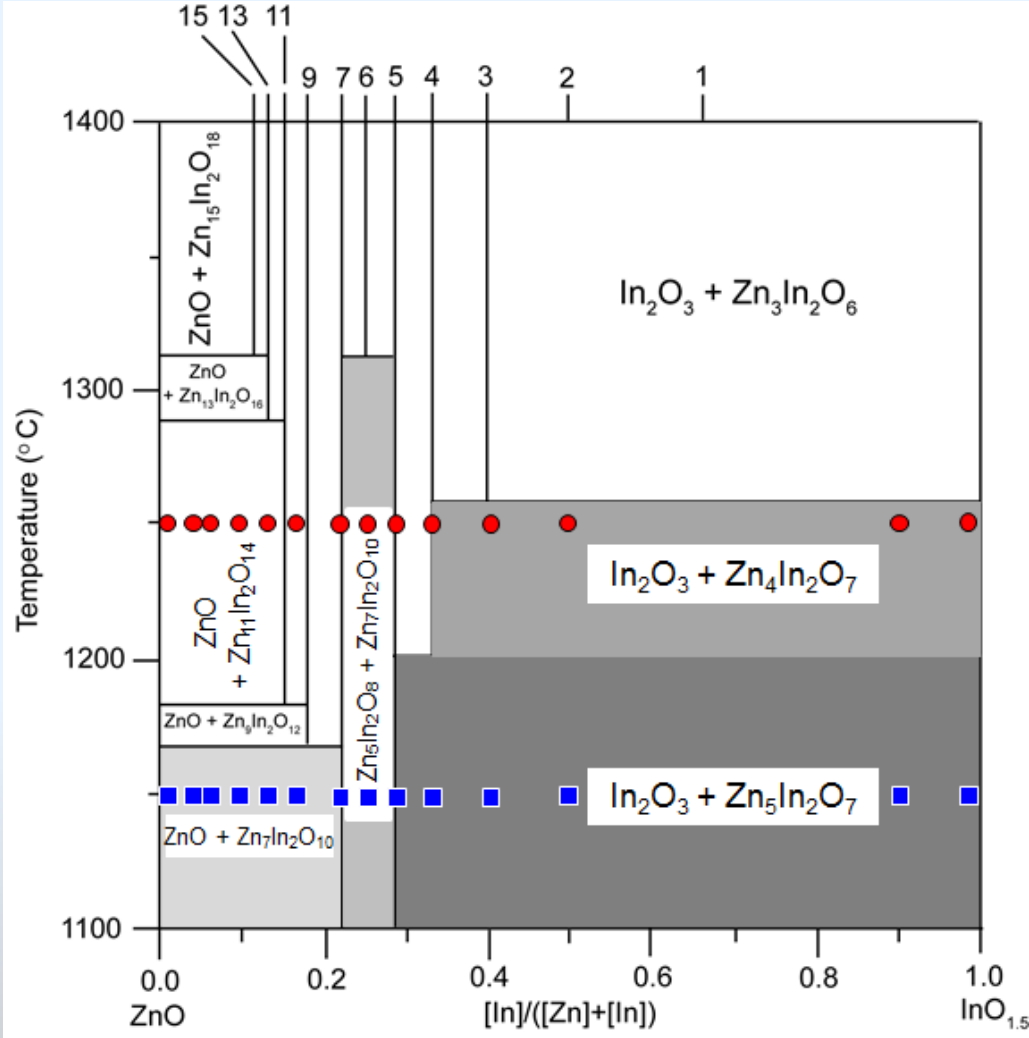

Natural Superlattices Decrease Thermal Conductivity

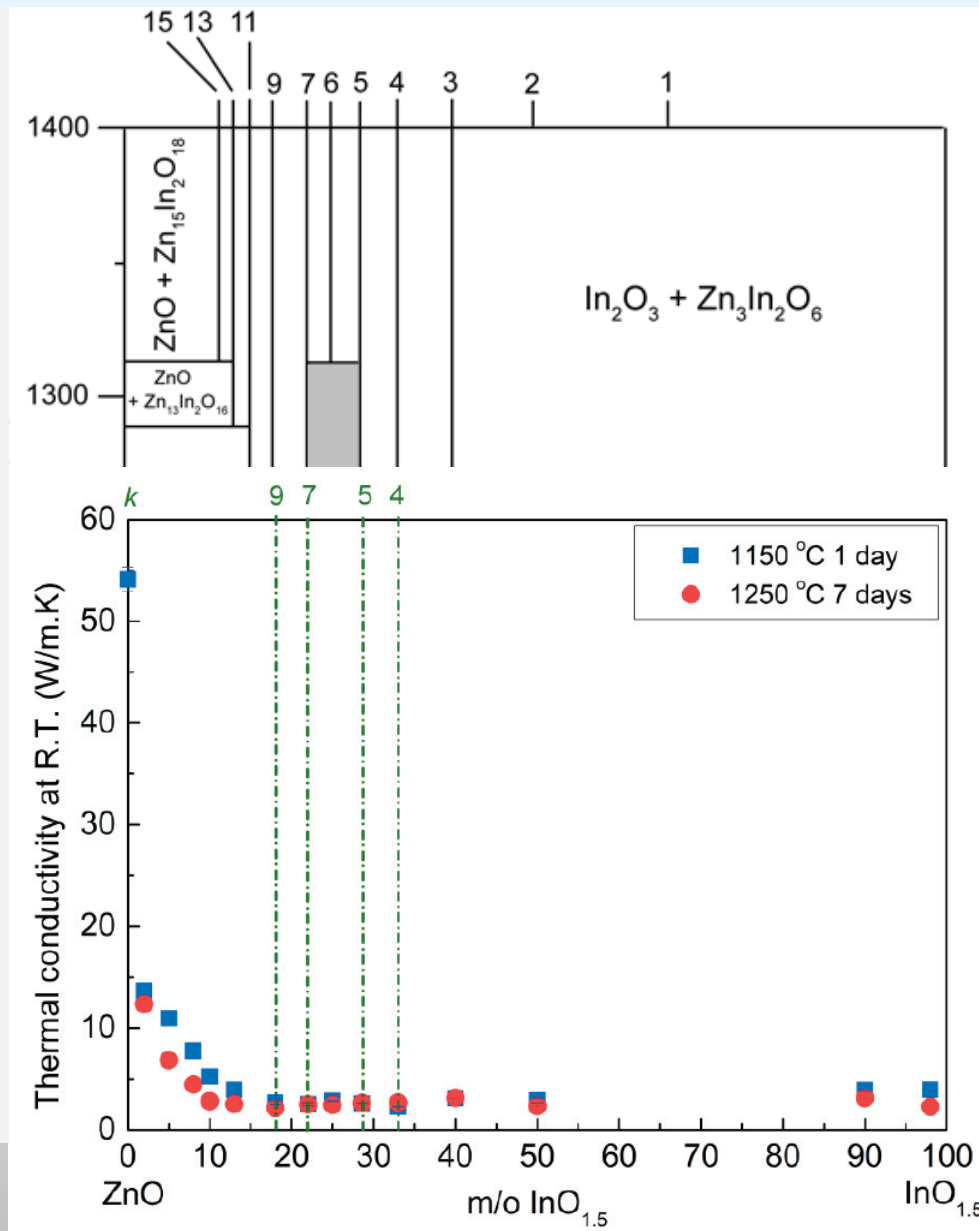

Liang and Clarke,
APL, 2013



ZT of Natural Superlattices: $(\text{ZnO})_k \cdot \text{In}_2\text{O}_3$

Model system

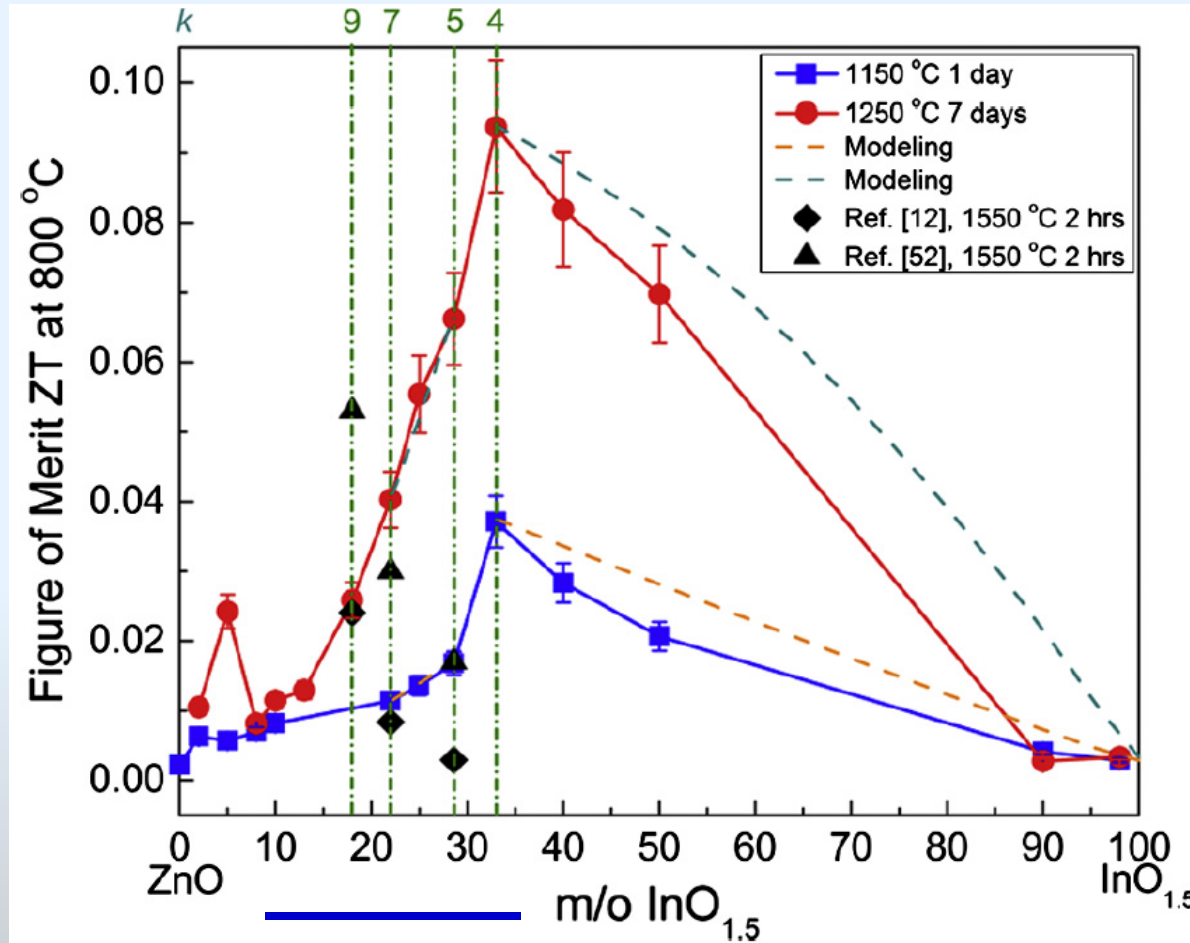

Range over which NSL form



Annular Thermoelectric Design For High-Temperature Pipes

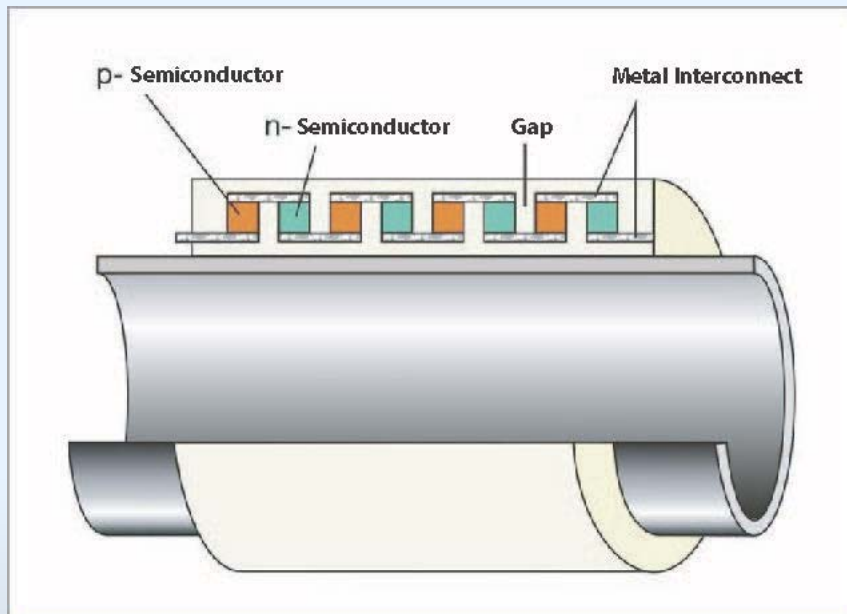

Fraunhofer Institute

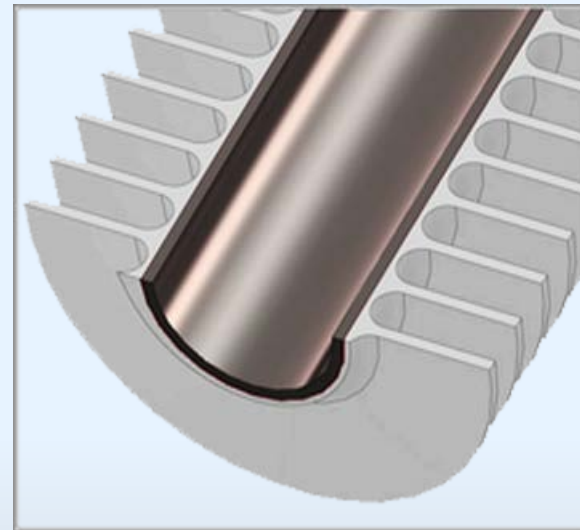

Conformal geometry
Large scale



From Materials To Devices

Material ZT

$$ZT = \frac{S^2 \sigma}{(\kappa_{el} + \kappa_L)} \cdot T$$

Device / Module ZT

$$Z_{Device} T = \frac{S^2}{\kappa_{Device} R_{Device}} T$$

Dimensions dictated by electrical and thermal resistances as well as temperature difference

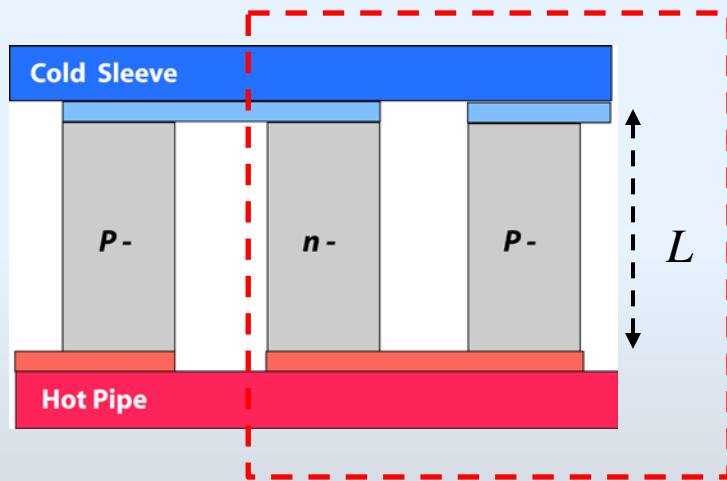

$$\kappa_{Device} = \frac{A_n}{L} \kappa_n + \frac{A_p}{L} \kappa_p + \frac{A}{\kappa_{contact}}$$

$$\begin{aligned} R_{Device} &= R_{legs} + R_{contact} + R_{interconnect} \\ &= \frac{L}{A_n} \rho_n + \frac{L}{A_p} \rho_p + R_{contact} + R_{interconnect} \end{aligned}$$

*Contact resistances and interconnect resistances must be minimized
NB. Dependence on L and A of the TE legs*



High-Temperature Thermoelectric Devices: Some Challenges

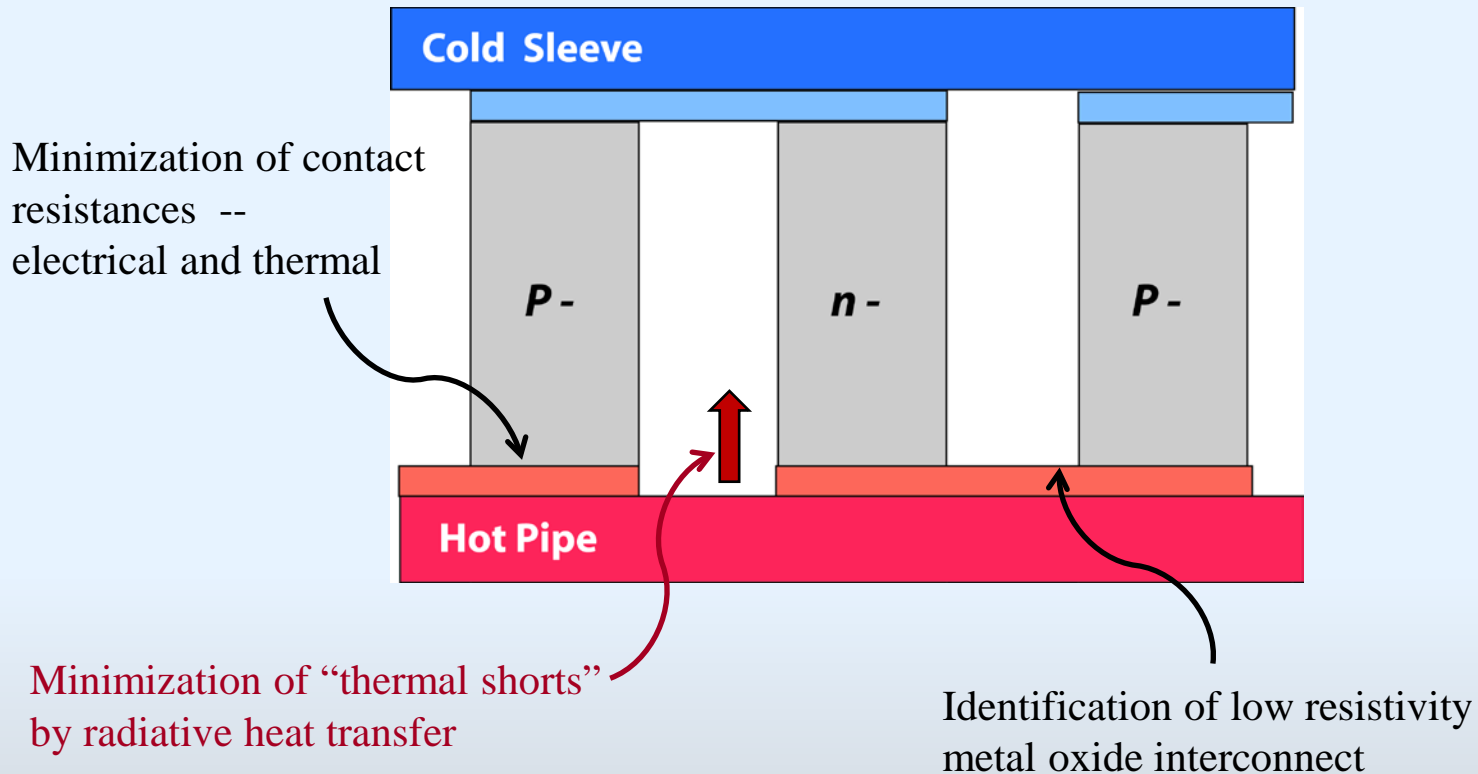

Also, required: minimization of long-term chemical inter-diffusion



Inter-connect Conducting Oxides

- Limited number of electrically conducting oxides exist, eg, ZnO, LaSrCrO
- Some guidance comes from electrode development for solid oxide fuel cells
- Identification of lower resistivity, high-temperature oxides should be a research priority
- Platinum is possible short-term solution but is far too expensive and also undergoes morphological instability and evaporation in air



The Challenge of Minimizing Radiative Heat Transfer

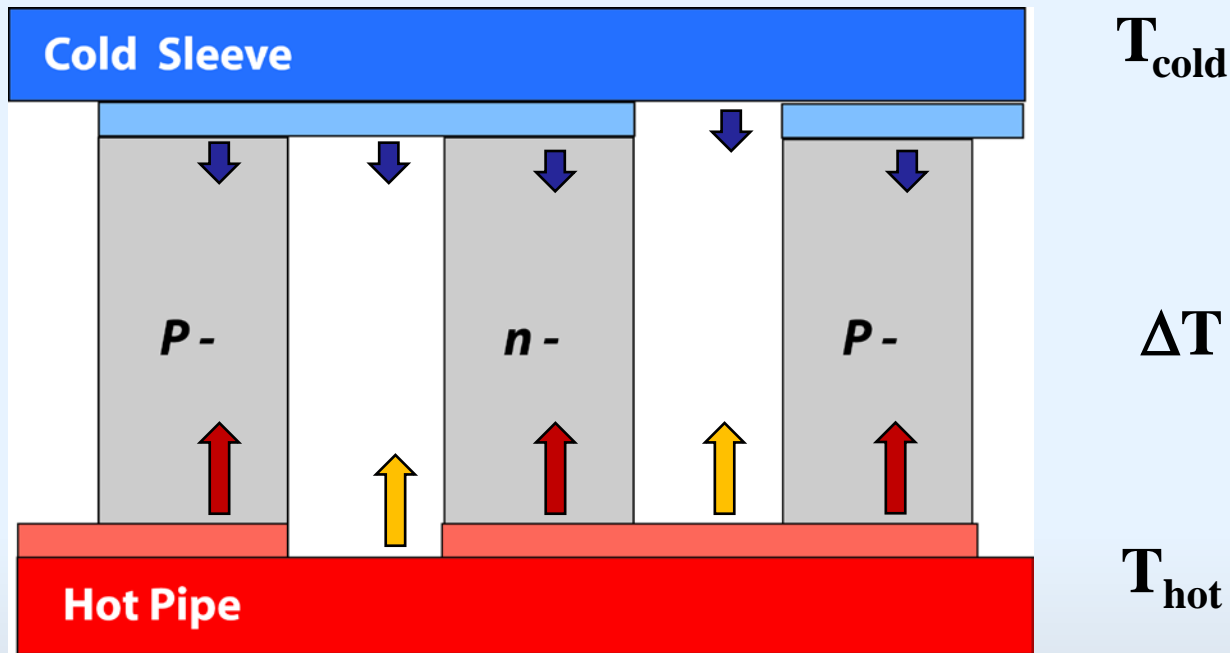

Problem:
$$q_{hc} = q_{\text{hot}} - q_{\text{cold}} = A \sigma (\epsilon_h T_h^4 - \epsilon_c T_c^4) \approx A \sigma (T_h^2 + T_c^2)(T_h + T_c) \Delta T$$

*Radiative exchange between hot and cold surfaces short-circuits the TE elements
----- gets worse at higher temperatures.*



The Challenge of Minimizing Radiative Heat Transfer

*Plasma-spray very porous YSZ into gaps to reduce radiative transfer
(technology transfer from TBC community)*

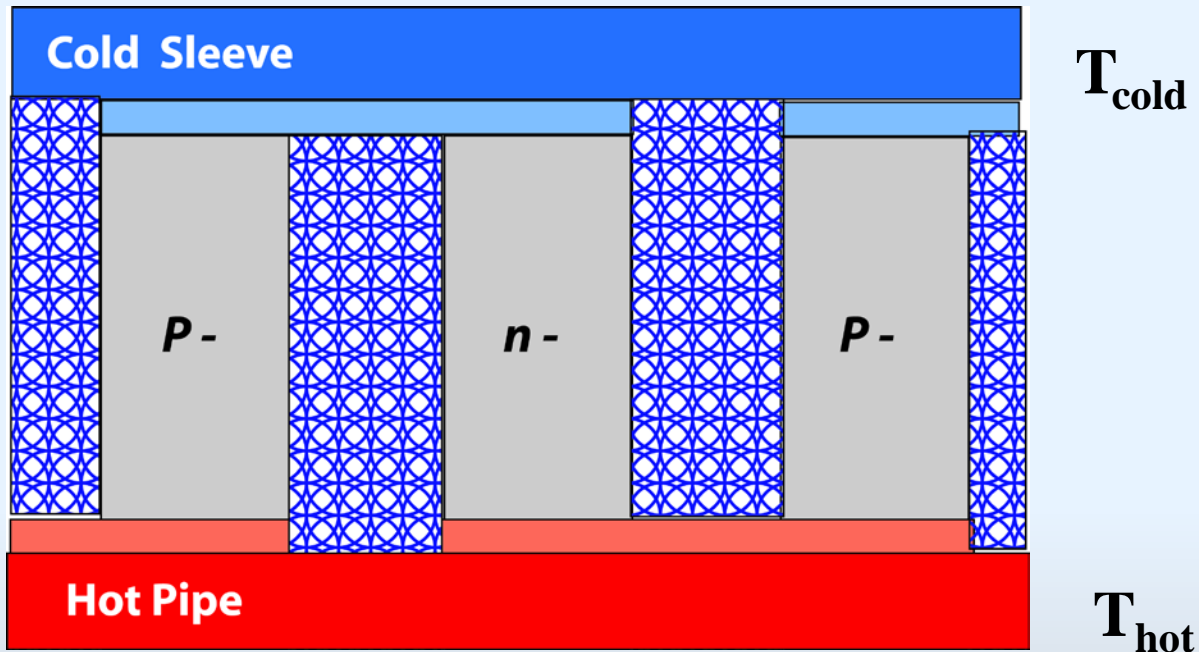

*Introduce micron-sized porosity into TE materials themselves
Radiation scattering is maximum when pore diameter \sim IR wavelength*



Output Power

- Device design optimizes output power
- Design objective of conventional thermoelectric devices minimizes
 - weight, or
 - size, or
 - volume of TE material
- Industrial use of oxide thermoelectrics may require different design objectives
- Output power, P_o , is given by

$$P_o = \frac{S^2 (\Delta T)^2}{2((R + R_{Load}))} = \frac{S^2 (\Delta T)^2}{4 R}$$

- But what sets size ?
- Internal resistance:

$$R \approx \frac{4 L \bar{\rho}}{A_T} \quad \longrightarrow \quad P_o = \frac{S^2}{\rho} \frac{A_T}{16 L} (\Delta T)^2$$

From Ure and Heikes, “Science and Engineering of Thermoelectrics”,

Recipe For Commercial Success In The Materials Area

- Provide a product designer with a new functionality
- Ensure the designer has familiarity with the materials
- Absence of competing materials
- Ability to form complex shapes
- Availability of source materials
- Ability to join different materials
- Performance advantage
- Ability to amortize costs over several years so capital costs do not dominate life-cycle costs



HARVARD

School of Engineering
and Applied Sciences

Thermo-electric Generator Today

Flat geometry

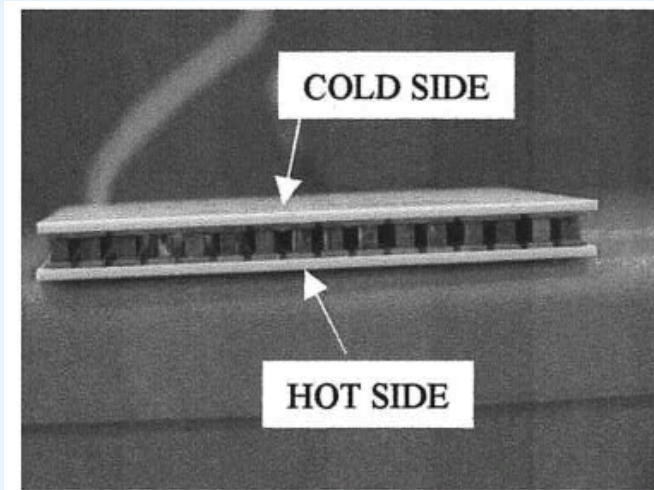

Bi_2Te_3 , PbTe

Cutting, dicing and soldering



Assembly required

Fabrication process is based on semiconductor wafer processing paradigm and packaging technologies. Also, relatively small in size, ~ centimeters



HARVARD

School of Engineering
and Applied Sciences

Two Examples of Oxide Thermoelectric Modules



Urata et al, Int. J. Appl Ceram Tech, 4 535 (2007)

p -type: $\text{Ca}_{2.7}\text{Bi}_{0.3}\text{Co}_4\text{O}_9$
 n -type: $\text{CaMn}_{0.98}\text{Mo}_{0.02}\text{O}_3$
 $L = 4.5$ mm, 8 pairs of legs
silver interconnect
 0.34 W at $T_h = 1000^\circ\text{C}$

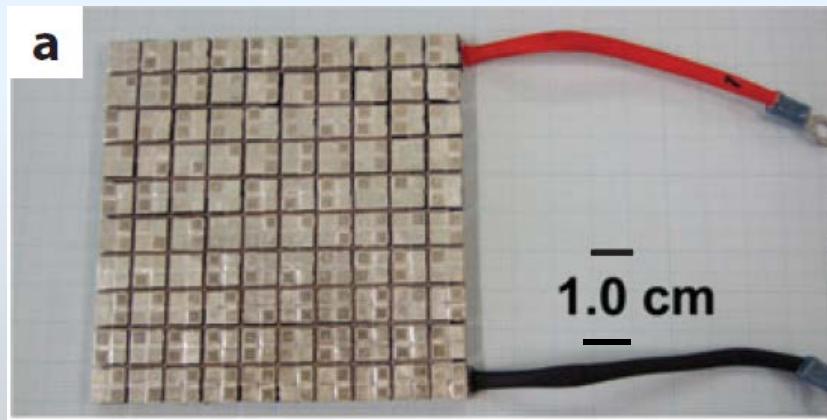

Funahashi, unpublished.
Quoted by Kuomoto, Annual Reviews of Materials Res, 2010)

p -type: $\text{Ca}_{2.7}\text{Bi}_{0.3}\text{Co}_4\text{O}_9$
 n -type: $\text{Ca}_{0.9}\text{MnYb}_{0.1}\text{O}_3$
 $L = 5$ mm, 100 pairs of legs
silver interconnect
 12 W at $T_h = 800^\circ\text{C}$. $\Delta T = 400$ C

*Important first steps but
follows the wafer processing paradigm !*

Strengths of the Ceramics Community

- Expertise in processing powders to form intricate shapes
- Variety of powder processing technologies – sintering, hot forging, plasma spraying
- Understanding high-temperature phase equilibria
- Familiarity with complex crystal chemistry
- Manipulating electronic and ionic transport in oxides
- Familiarity with thermal stresses and thermal shock
- Knowledge and processing high-temperature materials, eg
 - Oxide fuel cells
 - Nuclear fuels
 - Thermal barrier coatings
 - Structural ceramics
- Understanding oxidation processes



HARVARD

School of Engineering
and Applied Sciences

Building on Ceramics Community Skills



Net shape forming

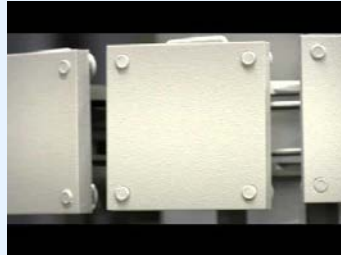

Solid oxide fuel cell by spraying



Injection molding. Kyocera, Silicon nitride

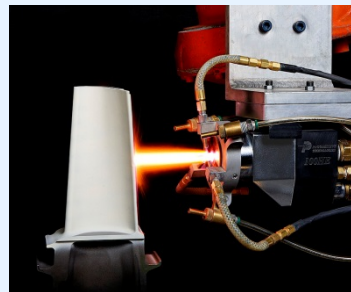

Thermal barrier coating

Transient liquid bonding



Direct spray writing
Mesoscribe, Inc

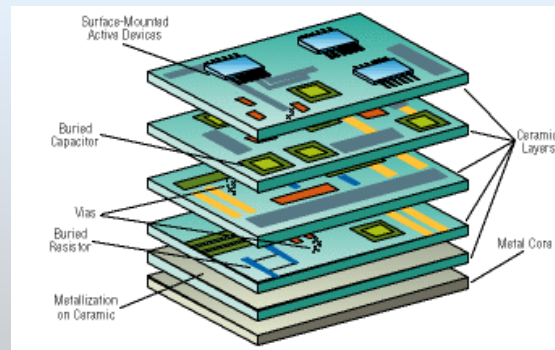

Low temperature hybrid manufacturing

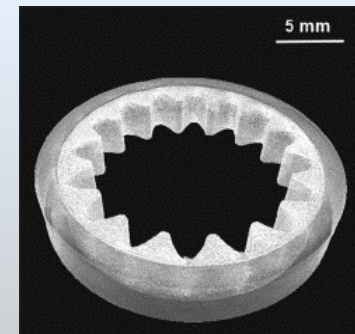

Net shape forming and cofiring

Possible Fabrication of Oxide Thermoelectric Devices

Guiding principles:

- Always fabricate devices at a higher temperature than they will be used at
- Preferred process technology determined by shape

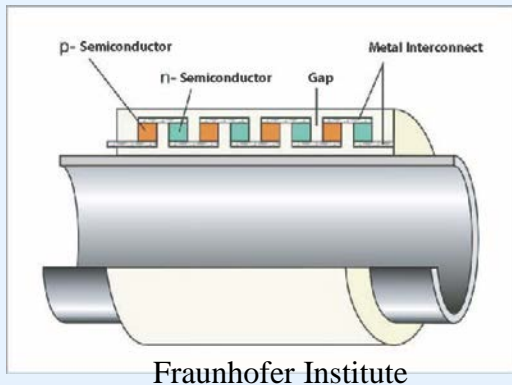

Split, clam-shell design
with annular arrays of junctions

- *Electrophoretic deposition or direct write conducting metal oxide (CMO) onto mandrel*
- *Laser ablation patterning of CMO electrode*
- *Green shaping of rings of TE oxides*
- *Co-firing rings to conducting oxide electrode pads*
- *Deposition of outer electrodes by plasma spraying*
- *In-gap spraying of zirconia thermal barrier*
- *Air annealing to stabilize device*



Concluding Remarks

- Oxide thermoelectric generators are a potential new application for high-temperature ceramics.
- As a community we should not wait for the “best” TE material before demonstrating devices and developing technology.
- We should begin to build high-temperature generators using existing TE oxide materials in parallel to identifying better oxide TE materials.
- Develop processes for fabricating cylindrical TE Devices.
- A major research effort in discovering low resistivity oxides is needed
- Data mining is a powerful tool in selecting promising classes of materials for further study.
- International partnerships offer the opportunities to bring together essential skills and accelerate development



HARVARD

School of Engineering
and Applied Sciences